

# **INTERMAC MASTER**

**Centri di lavoro**  
Work centres



Catalogo Ricambi  
Spare Parts Catalogue  
Rel. 004



Il presente documento annulla e sostituisce tutte le precedenti versioni emesse.  
La Intermac si riserva il diritto di apportare modifiche alla presente documentazione in qualsiasi momento e senza preavviso.  
L'uso della stessa avviene da parte dell'utente sotto la propria responsabilità, sono escluse pertanto responsabilità della Intermac per danni diretti o indiretti dovuti all'uso di tale documentazione.  
La riproduzione o distribuzione di questo documento o parte di esso non è autorizzata.

The present document delete and replace the precedent version released.  
Intermac reserves the right at any time to alter this document without any notice whatsoever.  
The customer will use it under his own responsibility. Intermac shall not be liable for any direct or indirect damages due to an improper use of it.  
Unauthorized reproduction or distribution of this document, or any portion of it is not authorized.

**Intermac**

Via dell'Economia, 40  
61122 Pesaro PU - Italy  
Tel. +39 0721 483500  
Fax +39 0721 481962  
[www.intermac.com](http://www.intermac.com)  
[intermac.parts@intermac.com](mailto:intermac.parts@intermac.com)



**CONI - TOOL HOLDERS ISO 40**

<b>Codice Codes</b>	<b>Descrizione Description</b>	<b>Diametro Diameter</b>	<b>Altezza Height</b>
P6390P0036	Mola Alta - High Wheel	22	34
P6390P0037	Mola Bassa - Low Wheel	22	34
P6390P0040	Doppia mola - Double Wheel	22	47
P611301500	Fresa / Foretto - 1/2 gas Routers / Drills - 1/2 Inch gas		
P6390P0038	Mola Alta - High Wheel	35	34
P6390P0039	Mola Bassa - Low Wheel	35	34
P6390P0041	Doppia mola - Double Wheel	35	47
P6408P0001	Cono Potenza - Block Stone Tools	50	5
P6390P0042	Mola a tazza - Bevelling Wheel	22	14
P6390P0035	Diametro 12 - Small Wheels	12	23
P6313P0003	Smorza Vibrazioni per frese - Antivibration for Routers 1/2 Inch gas		
KR35200066	Cono lungo - high length	22	75
P6390P0066	Posizionamento battute /Ventose Positioning Backstops / Suction cups		



Cono ISO 40 Fresa - Foretto



Cono ISO 40 Mola Alta

 Cono ISO 40  
Posizionamento battute ventose

 Cono ISO 40  
Smorzavibrazioni 1/2 gas

Cono ISO 40 Mola Bassa

**Intermac**

Via dell'Economia, 40  
61122 Pesaro PU - Italy  
Tel. +39 0721 483500  
Fax +39 0721 481962  
www.intermac.com  
intermac.parts@intermac.com



**CONI - TOOL HOLDERS ISO 30**

<b>Codice Codes</b>	<b>Descrizione Description</b>	<b>Diametro Diameter</b>	<b>Altezza Height</b>
P6390P0033	Mola Bassa - Low Wheel	22	23
P6390P0032	Mola Media - Medium Wheel	22	23
P6390P0034	Mola Alta - High Wheel	22	47
P6390P0031	Diametro 12 - Small Wheel	12	23

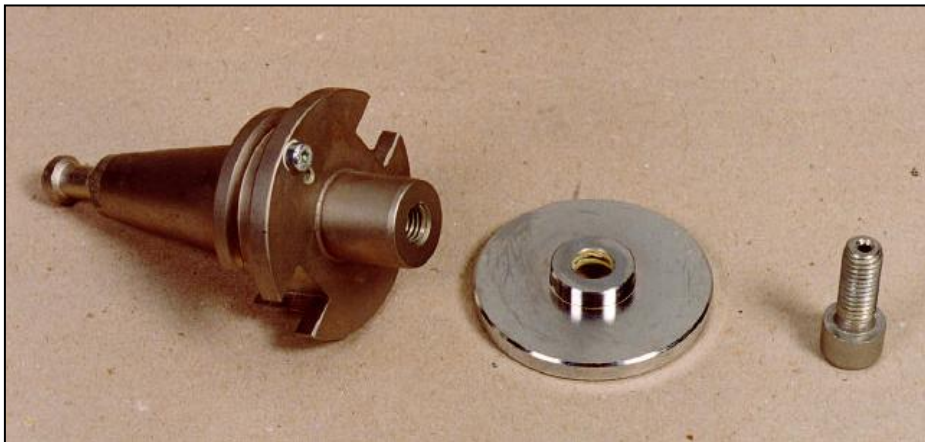





Cono ISO30

**Intermac**

Via dell'Economia, 40  
61122 Pesaro PU - Italy  
Tel. +39 0721 483500  
Fax +39 0721 481962  
www.intermac.com  
intermac.parts@intermac.com



## ACCESSORI PER CONI - ACCESSORIES FOR TOOL HOLDERS

<p><b>CODOLINI - TIE RODS</b>          Codolini ISO40 - Tie rods ISO40 = <b>P080706700</b></p> <p>Codolini ISO30 - Tie rods ISO30 = <b>P080702800</b>          (tutte le machine con Elettromandrino)          (All machines with Electrospindle)</p> <p>Codolini ISO30 - Tie rods ISO30 = <b>P080702900</b>          (Tutte le machine con pinza Berg, es: Master Groove, Master Maxi, Master 34)          (All machines with Berg mechanism, eg. Master Groove, Master Maxi, Master 34)</p>	
<p><b>VITI FORATE - SCREWS (with hole)</b>          M10x20 = <b>P0804P0164</b>          M10x25 = <b>P080406500</b> (suggested)</p> <p><b>VITI STANDARD - SCREWS (without hole)</b>          M10x25 = <b>3002A0824</b>          M10x35 = <b>3002A0926</b>          M6x20 = <b>3002A0822</b>          M6x25 = <b>3002A0831</b></p>	
<p><b>CHIUSURA - END CUP</b></p> <p><b>Mola Alta - High Wheel</b>          Iso 40 - ø 22 = <b>P080405200</b>          Iso 40 - ø 35 = <b>P110402400</b></p> <p><b>Mola Bassa - Low Wheel</b>          Iso 40 - ø 22 = <b>P080401400</b>          Iso 40 - ø 35 = <b>P110402500</b></p>	
<p><b>SPESSORI - SPACERS</b></p> <p>Diametro Interno 22mm = <b>P080406300</b></p> <p>Diametro Interno 35mm = <b>P080409500</b></p>	



<p><b>Contenitore Utensili 20 posizioni ISO40</b></p> <p><b>Tool Storage - 20 Positions ISO 40</b></p> <table border="1"> <tr> <td>Codice - Code</td> <td><b>P611602000</b></td> </tr> </table>	Codice - Code	<b>P611602000</b>					
Codice - Code	<b>P611602000</b>						
<p><b>AGGREGATO PER LA SCRITTURA SUPERFICIALE ISO40</b></p> <p><b>AGGREGATE FOR WRITING THE SHEET SURFACE ISO40</b></p> <table border="1"> <tr> <td>Codice - Code</td> <td><b>P6390P0020</b></td> </tr> </table>	Codice - Code	<b>P6390P0020</b>					
Codice - Code	<b>P6390P0020</b>						
<p><b>SPAZZOLA PULIZIA PIANO ISO40</b></p> <p><b>AGGREGATE UNIT SURFACE CLEANING BRUSH ISO40</b></p> <table border="1"> <tr> <td>Complete Group</td> <td><b>P6390P0204</b></td> </tr> <tr> <td>Spazzola/Brush</td> <td><b>DLG15711</b></td> </tr> <tr> <td>Attacco/ flange</td> <td><b>D9666</b></td> </tr> </table>	Complete Group	<b>P6390P0204</b>	Spazzola/Brush	<b>DLG15711</b>	Attacco/ flange	<b>D9666</b>	
Complete Group	<b>P6390P0204</b>						
Spazzola/Brush	<b>DLG15711</b>						
Attacco/ flange	<b>D9666</b>						
<p><b>DETERGENTE PER PULIZIA PIANO (1 Litro) (quantità minima 12 bottiglie)</b></p> <p><b>DETERGENT FOR BED WASH (1 Liter) (minimum quantities 12bottle)</b></p> <table border="1"> <tr> <td>Codice - Code</td> <td><b>3307A0033</b></td> </tr> </table>	Codice - Code	<b>3307A0033</b>					
Codice - Code	<b>3307A0033</b>						

## VENTOSE PER VETRO - SUCTION CUPS FOR GLASS MACHINERY

### DIAMETRO 65MM DIAMETER 65MM

Altezza - Height 105	<b>2428A0239</b>
Altezza - Height 150	<b>2428A0243</b>
Altezza - Height 213	<b>2428A0251</b>
<b>Ricambi - Spare parts</b>	
Disco appoggio Disc support	<b>2428A0255</b>
Raccordo- Plug 8mm	<b>245100900</b>
Gomma - Top rubber	<b>FNAW550114</b>
ORInferiore-Bottom	<b>311012900</b>



### DIAMETRO 90MM DIAMETER 90MM

Altezza - Height 105	<b>2428A0240</b>
Altezza - Height 150	<b>2428A0244</b>
Altezza - Height 213	<b>2428A0252</b>
<b>Ricambi - Spare parts</b>	
Disco appoggio Disc support	<b>2428A0256</b>
Gomma - Rubber	<b>P1453P0011</b>
Raccordo-Plug 8mm	<b>245100900</b>
ORInferiore-Bottom	<b>311012900</b>



### DIAMETRO 120MM DIAMETER 120MM

Altezza - Height 105	<b>2428A0241</b>
Altezza - Height 150	<b>2428A0245</b>
Altezza - Height 213	<b>2428A0253</b>
<b>Ricambi - Spare parts</b>	
Disco appoggio Disc support	<b>2428A0257</b>
Gomma - Rubber	<b>P1453P0009</b>
Raccordo-Plug 8mm	<b>245100900</b>
ORInferiore-Bottom	<b>311012900</b>



Intermac

Via dell'Economia, 40  
61122 Pesaro PU - Italy  
Tel. +39 0721 483500  
Fax +39 0721 481962  
www.intermac.com  
intermac.parts@intermac.com



<b>DIAMETRO 160MM</b> <b>DIAMETER 160MM</b>		
Altezza - Height 105	<b>2428A0242</b>	
Altezza - Height 150	<b>2428A0246</b>	
Altezza - Height 213	<b>2428A0254</b>	
<b>Ricambi - Spare parts</b>		
Disco appoggio Disc support	<b>2428A0258</b>	
Gomma - Rubber	<b>P1453P0010</b>	
Raccordo-Plug 8mm	<b>245100900</b>	
ORInferiore-Bottom	<b>311014200</b>	

## VENTOSE PER MARMO - SUCTION CUPS FOR STONE MACHINERY

<b>DIAMETRO 65MM</b> <b>DIAMETER 65MM</b>		
Altezza - Height 105	<b>2428A0239</b>	
Altezza - Height 150	<b>2428A0243</b>	
Altezza - Height 213	<b>2428A0251</b>	
<b>Ricambi - Spare parts</b>		
Disco appoggio Disc support	<b>2428A0255</b>	
Raccordo- Plug 8mm	<b>245100900</b>	
Gomma - Top rubber	<b>FNAW550114</b>	
ORInferiore-Bottom	<b>311012900</b>	

<b>DIAMETRO 90MM MARMO</b> <b>DIAMETER 90MM (STONE)</b>		
Altezza - Height 105	<b>P6390P0148</b>	
Altezza - Height 150	<b>P6390P0200</b>	
Altezza - Height 213	<b>P6390P0151</b>	
<b>Ricambi - Spare parts</b>		
Disco appoggio Disc support	<b>2428A0256</b>	
Gomma - Rubber	<b>P1453P0011</b>	
Raccordo-Plug 8mm	<b>245100900</b>	
Neoprene - Gasket	<b>3123A0262</b>	
ORInferiore-Bottom	<b>311012900</b>	



**DIAMETRO 120MM MARMO  
DIAMETER 120MM (STONE)**

Altezza - Height 105	<b>P6390P0149</b>
Altezza - Height 150	<b>P6390P0198</b>
Altezza - Height 213	<b>P6390P0152</b>

**Ricambi - Spare parts**

Disco appoggio Disc support	<b>2428A0257</b>
Gomma - Rubber	<b>P1453P0009</b>
Raccordo-Plug 8mm	<b>245100900</b>
ORInferiore-Bottom	<b>311012900</b>



**DIAMETRO 160MM MARMO  
DIAMETER 160MM (STONE)**

Altezza - Height 105	<b>P6390P0150</b>
Altezza - Height 150	<b>P6390P0199</b>
Altezza - Height 213	<b>P6390P0153</b>

**Ricambi - Spare parts**

Disco appoggio Disc support	<b>2428A0258</b>
Gomma - Rubber	<b>P1453P0010</b>
Raccordo-Plug 8mm	<b>245100900</b>
Neoprene - Gasket	<b>3123A0264</b>
ORInferiore-Bottom	<b>311014200</b>



## VENTOSE QUADRATE - SQUARE SUCTION CUPS

### 100x100 MM

Altezza - Height 105	<b>P6308P0002</b>
Altezza - Height 150	<b>P6308P0003</b>
Altezza - Height 213	<b>P6308P0024</b>

#### Ricambi - Spare parts

Piedino - Polo mints	<b>P163000200</b>
Raccordo-Plug 8mm	<b>245124100</b>
Neoprene15x10mm - Foam15x10mm	<b>3123A0303</b>

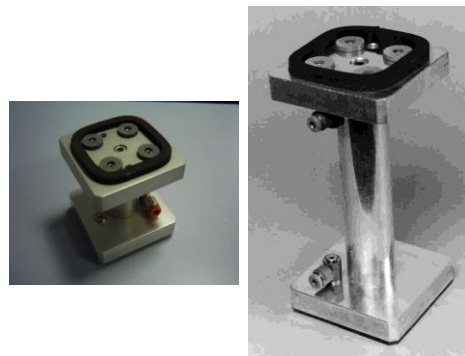

### 150x150 MM

Altezza - Height 105	<b>P6308P0008</b>
Altezza - Height 150	<b>P6308P0009</b>
Altezza - Height 213	<b>P6308P0027</b>

#### Ricambi - Spare parts

Piedino - Polo mints	<b>P163000200</b>
Raccordo-Plug 8mm	<b>245124100</b>
Neoprene15x10mm Foam15x10mm	<b>3123A0303</b>

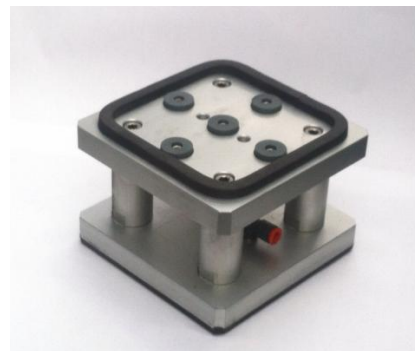

### 200x200 MM

Altezza - Height 105	<b>P6308P0013</b>
Altezza - Height 150	<b>P6308P0014</b>
Altezza - Height 213	<b>P6308P0029</b>

#### Ricambi - Spare parts

Piedino - Polo mints	<b>P163000200</b>
Raccordo-Plug 8mm	<b>245124100</b>
Neoprene15x10mm Foam15x10mm	<b>3123A0303</b>



Intermac

Via dell'Economia, 40  
61122 Pesaro PU - Italy  
Tel. +39 0721 483500  
Fax +39 0721 481962  
www.intermac.com  
intermac.parts@intermac.com



## VENTOSE RETTANGOLARI - RECTANGULAR SUCTION CUPS

<p><b>100x40 MM</b></p> <table border="1"> <tr> <td>Altezza - Height 105</td> <td><b>P610208500</b></td> </tr> <tr> <td>Altezza - Height 150</td> <td><b>P6308P0111</b></td> </tr> <tr> <td>Altezza - Height 213</td> <td><b>P630800700</b></td> </tr> <tr> <td colspan="2"><b>Ricambi - Spare parts</b></td> </tr> <tr> <td>Raccordo-Plug 8mm</td> <td><b>245100900</b></td> </tr> </table>	Altezza - Height 105	<b>P610208500</b>	Altezza - Height 150	<b>P6308P0111</b>	Altezza - Height 213	<b>P630800700</b>	<b>Ricambi - Spare parts</b>		Raccordo-Plug 8mm	<b>245100900</b>							
Altezza - Height 105	<b>P610208500</b>																
Altezza - Height 150	<b>P6308P0111</b>																
Altezza - Height 213	<b>P630800700</b>																
<b>Ricambi - Spare parts</b>																	
Raccordo-Plug 8mm	<b>245100900</b>																
<p><b>200x40 MM</b></p> <table border="1"> <tr> <td>Altezza - Height 105</td> <td><b>P630801700</b></td> </tr> <tr> <td>Altezza - Height 150</td> <td><b>P6308P0097</b></td> </tr> <tr> <td>Altezza - Height 213</td> <td><b>P6308P0110</b></td> </tr> <tr> <td colspan="2"><b>Ricambi - Spare parts</b></td> </tr> <tr> <td>Raccordo-Plug 8mm</td> <td><b>245100900</b></td> </tr> </table>	Altezza - Height 105	<b>P630801700</b>	Altezza - Height 150	<b>P6308P0097</b>	Altezza - Height 213	<b>P6308P0110</b>	<b>Ricambi - Spare parts</b>		Raccordo-Plug 8mm	<b>245100900</b>							
Altezza - Height 105	<b>P630801700</b>																
Altezza - Height 150	<b>P6308P0097</b>																
Altezza - Height 213	<b>P6308P0110</b>																
<b>Ricambi - Spare parts</b>																	
Raccordo-Plug 8mm	<b>245100900</b>																
<p><b>100x200 MM</b></p> <table border="1"> <tr> <td>Altezza - Height 105</td> <td><b>P6308P0004</b></td> </tr> <tr> <td>Altezza - Height 150</td> <td><b>P6308P0005</b></td> </tr> <tr> <td>Altezza - Height 213</td> <td><b>P6308P0025</b></td> </tr> <tr> <td colspan="2"><b>Ricambi - Spare parts</b></td> </tr> <tr> <td>Piedino - Polo mints</td> <td><b>P163000200</b></td> </tr> <tr> <td>Raccordo-Plug 8mm</td> <td><b>245128600</b></td> </tr> <tr> <td>Neoprene15x10mm</td> <td><b>3123A0303</b></td> </tr> <tr> <td>Foam15x10mm</td> <td></td> </tr> </table>	Altezza - Height 105	<b>P6308P0004</b>	Altezza - Height 150	<b>P6308P0005</b>	Altezza - Height 213	<b>P6308P0025</b>	<b>Ricambi - Spare parts</b>		Piedino - Polo mints	<b>P163000200</b>	Raccordo-Plug 8mm	<b>245128600</b>	Neoprene15x10mm	<b>3123A0303</b>	Foam15x10mm		
Altezza - Height 105	<b>P6308P0004</b>																
Altezza - Height 150	<b>P6308P0005</b>																
Altezza - Height 213	<b>P6308P0025</b>																
<b>Ricambi - Spare parts</b>																	
Piedino - Polo mints	<b>P163000200</b>																
Raccordo-Plug 8mm	<b>245128600</b>																
Neoprene15x10mm	<b>3123A0303</b>																
Foam15x10mm																	
<p><b>100x300 MM</b></p> <table border="1"> <tr> <td>Altezza - Height 105</td> <td><b>P6308P0006</b></td> </tr> <tr> <td>Altezza - Height 150</td> <td><b>P6308P0007</b></td> </tr> <tr> <td>Altezza - Height 213</td> <td><b>P6308P0026</b></td> </tr> <tr> <td colspan="2"><b>Ricambi - Spare parts</b></td> </tr> <tr> <td>Piedino - Polo mints</td> <td><b>P163000200</b></td> </tr> <tr> <td>Raccordo-Plug 8mm</td> <td><b>245128600</b></td> </tr> <tr> <td>Neoprene15x10mm</td> <td><b>3123A0303</b></td> </tr> <tr> <td>Foam15x10mm</td> <td></td> </tr> </table>	Altezza - Height 105	<b>P6308P0006</b>	Altezza - Height 150	<b>P6308P0007</b>	Altezza - Height 213	<b>P6308P0026</b>	<b>Ricambi - Spare parts</b>		Piedino - Polo mints	<b>P163000200</b>	Raccordo-Plug 8mm	<b>245128600</b>	Neoprene15x10mm	<b>3123A0303</b>	Foam15x10mm		
Altezza - Height 105	<b>P6308P0006</b>																
Altezza - Height 150	<b>P6308P0007</b>																
Altezza - Height 213	<b>P6308P0026</b>																
<b>Ricambi - Spare parts</b>																	
Piedino - Polo mints	<b>P163000200</b>																
Raccordo-Plug 8mm	<b>245128600</b>																
Neoprene15x10mm	<b>3123A0303</b>																
Foam15x10mm																	

Intermac

Via dell'Economia, 40  
 61122 Pesaro PU - Italy  
 Tel. +39 0721 483500  
 Fax +39 0721 481962  
 www.intermac.com  
 intermac.parts@intermac.com



## 150x300 MM

Altezza - Height 105	<b>P6308P0010</b>
Altezza - Height 150	<b>P6308P0011</b>
Altezza - Height 213	<b>P6308P0028</b>
<b>Ricambi - Spare parts</b>	
Piedino - Polo mints	<b>P163000200</b>
Raccordo-Plug 8mm	<b>245128600</b>
Neoprene15x10mm	<b>3123A0303</b>
Foam15x10mm	

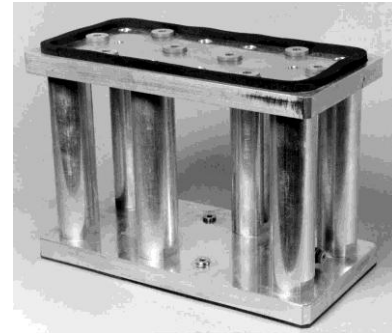

## 200x300 MM

Altezza - Height 105	<b>P6308P0016</b>
Altezza - Height 150	<b>P6308P0017</b>
Altezza - Height 213	<b>P6308P0030</b>
<b>Ricambi - Spare parts</b>	
Piedino - Polo mints	<b>P163000200</b>
Raccordo-Plug 8mm	<b>245128600</b>
Neoprene15x10mm	<b>3123A0303</b>
Foam15x10mm	



## 200x400 MM

Altezza - Height 105	<b>P6308P0019</b>
Altezza - Height 150	<b>P6308P0020</b>
Altezza - Height 213	<b>P6308P0031</b>
<b>Ricambi - Spare parts</b>	
Piedino - Polo mints	<b>P163000200</b>
Raccordo-Plug 8mm	<b>245128600</b>
Neoprene15x10mm	<b>3123A0303</b>
Foam15x10mm	



Intermac

Via dell'Economia, 40  
61122 Pesaro PU - Italy  
Tel. +39 0721 483500  
Fax +39 0721 481962  
www.intermac.com  
intermac.parts@intermac.com



## VENTOSE CURVE/SPECIALI – CURVED/SPECIAL SUCTION CUPS

<p><b>Ventose Curve H105mm Curved Suction H105mm</b></p> <table border="1"> <tr> <td>Raggio/Radius 150</td> <td><b>P630803300</b></td> </tr> <tr> <td>Raggio/Radius 180</td> <td><b>P630803000</b></td> </tr> <tr> <td>Raggio/Radius 240</td> <td><b>P630803200</b></td> </tr> <tr> <td>Raggio/Radius 490</td> <td><b>P630803100</b></td> </tr> <tr> <td>Raggio/Radius 263</td> <td><b>P630800100</b></td> </tr> <tr> <td colspan="2"><b>Ricambi - Spare parts</b></td> </tr> <tr> <td>Raccordo-Plug 8mm</td> <td><b>245100900</b></td> </tr> <tr> <td>OR - Gasket</td> <td><b>3110A2212</b></td> </tr> </table>	Raggio/Radius 150	<b>P630803300</b>	Raggio/Radius 180	<b>P630803000</b>	Raggio/Radius 240	<b>P630803200</b>	Raggio/Radius 490	<b>P630803100</b>	Raggio/Radius 263	<b>P630800100</b>	<b>Ricambi - Spare parts</b>		Raccordo-Plug 8mm	<b>245100900</b>	OR - Gasket	<b>3110A2212</b>	
Raggio/Radius 150	<b>P630803300</b>																
Raggio/Radius 180	<b>P630803000</b>																
Raggio/Radius 240	<b>P630803200</b>																
Raggio/Radius 490	<b>P630803100</b>																
Raggio/Radius 263	<b>P630800100</b>																
<b>Ricambi - Spare parts</b>																	
Raccordo-Plug 8mm	<b>245100900</b>																
OR - Gasket	<b>3110A2212</b>																
<p><b>100X40MM *SPECIAL*</b></p> <table border="1"> <tr> <td>Altezza - Height 105 Base – lower plate 100x100mm</td> <td><b>2428A0233</b></td> </tr> </table>	Altezza - Height 105 Base – lower plate 100x100mm	<b>2428A0233</b>															
Altezza - Height 105 Base – lower plate 100x100mm	<b>2428A0233</b>																
<p><b>200X40 MM *SPECIAL*</b></p> <table border="1"> <tr> <td>Altezza - Height 105 Base – lower plate 200x100mm</td> <td><b>2428A0232</b></td> </tr> </table>	Altezza - Height 105 Base – lower plate 200x100mm	<b>2428A0232</b>															
Altezza - Height 105 Base – lower plate 200x100mm	<b>2428A0232</b>																
<p><b>VENTOSA A "L" "L" SUCTION CUPS</b></p> <table border="1"> <tr> <td>H=105mm</td> <td><b>P630802100</b></td> </tr> <tr> <td colspan="2"><b>Ricambi - Spare parts</b></td> </tr> <tr> <td>Raccordo-Plug 8mm</td> <td><b>245100900</b></td> </tr> </table>	H=105mm	<b>P630802100</b>	<b>Ricambi - Spare parts</b>		Raccordo-Plug 8mm	<b>245100900</b>											
H=105mm	<b>P630802100</b>																
<b>Ricambi - Spare parts</b>																	
Raccordo-Plug 8mm	<b>245100900</b>																

Intermac

Via dell'Economia, 40  
61122 Pesaro PU - Italy  
Tel. +39 0721 483500  
Fax +39 0721 481962  
www.intermac.com  
intermac.parts@intermac.com





## RICAMBI PER VENTOSE "VECCHIO TIPO" SPARE PARTS FOR SUCTION CUPS "OLD GENERATION"

<p><b>DIAMETRO 65MM DIAMETER 65MM</b></p> <table border="1" style="width: 100%; border-collapse: collapse; margin-top: 10px;"> <thead> <tr> <th colspan="2" style="text-align: left;"><b>Ricambi - Spare parts</b></th> </tr> </thead> <tbody> <tr> <td>Piedino - Polo mints</td> <td style="text-align: right;"><b>P163000200</b></td> </tr> <tr> <td>Raccordo- Plug 8mm</td> <td style="text-align: right;"><b>245100900</b></td> </tr> <tr> <td>Gomma - Top rubber</td> <td style="text-align: right;"><b>P271100400</b></td> </tr> <tr> <td>ORInferiore-Bottom</td> <td style="text-align: right;"><b>3110A2205</b></td> </tr> </tbody> </table>	<b>Ricambi - Spare parts</b>		Piedino - Polo mints	<b>P163000200</b>	Raccordo- Plug 8mm	<b>245100900</b>	Gomma - Top rubber	<b>P271100400</b>	ORInferiore-Bottom	<b>3110A2205</b>	
<b>Ricambi - Spare parts</b>											
Piedino - Polo mints	<b>P163000200</b>										
Raccordo- Plug 8mm	<b>245100900</b>										
Gomma - Top rubber	<b>P271100400</b>										
ORInferiore-Bottom	<b>3110A2205</b>										
<p><b>DIAMETRO 90MM DIAMETER 90MM</b></p> <table border="1" style="width: 100%; border-collapse: collapse; margin-top: 10px;"> <thead> <tr> <th colspan="2" style="text-align: left;"><b>Ricambi - Spare parts</b></th> </tr> </thead> <tbody> <tr> <td>Piedino - Polo mints</td> <td style="text-align: right;"><b>P163000200</b></td> </tr> <tr> <td>Raccordo- Plug 8mm</td> <td style="text-align: right;"><b>245100900</b></td> </tr> <tr> <td>Gomma - Top rubber</td> <td style="text-align: right;"><b>P271100100</b></td> </tr> <tr> <td>ORInferiore-Bottom</td> <td style="text-align: right;"><b>3110A2212</b></td> </tr> </tbody> </table>	<b>Ricambi - Spare parts</b>		Piedino - Polo mints	<b>P163000200</b>	Raccordo- Plug 8mm	<b>245100900</b>	Gomma - Top rubber	<b>P271100100</b>	ORInferiore-Bottom	<b>3110A2212</b>	
<b>Ricambi - Spare parts</b>											
Piedino - Polo mints	<b>P163000200</b>										
Raccordo- Plug 8mm	<b>245100900</b>										
Gomma - Top rubber	<b>P271100100</b>										
ORInferiore-Bottom	<b>3110A2212</b>										
<p><b>DIAMETRO 120MM DIAMETER 120MM</b></p> <table border="1" style="width: 100%; border-collapse: collapse; margin-top: 10px;"> <thead> <tr> <th colspan="2" style="text-align: left;"><b>Ricambi - Spare parts</b></th> </tr> </thead> <tbody> <tr> <td>Piedino - Polo mints</td> <td style="text-align: right;"><b>P163000200</b></td> </tr> <tr> <td>Raccordo- Plug 8mm</td> <td style="text-align: right;"><b>245100900</b></td> </tr> <tr> <td>Gomma - Top rubber</td> <td style="text-align: right;"><b>P271100200</b></td> </tr> <tr> <td>ORInferiore-Bottom</td> <td style="text-align: right;"><b>3110A2216</b></td> </tr> </tbody> </table>	<b>Ricambi - Spare parts</b>		Piedino - Polo mints	<b>P163000200</b>	Raccordo- Plug 8mm	<b>245100900</b>	Gomma - Top rubber	<b>P271100200</b>	ORInferiore-Bottom	<b>3110A2216</b>	
<b>Ricambi - Spare parts</b>											
Piedino - Polo mints	<b>P163000200</b>										
Raccordo- Plug 8mm	<b>245100900</b>										
Gomma - Top rubber	<b>P271100200</b>										
ORInferiore-Bottom	<b>3110A2216</b>										
<p><b>DIAMETRO 160MM DIAMETER 160MM</b></p> <table border="1" style="width: 100%; border-collapse: collapse; margin-top: 10px;"> <thead> <tr> <th colspan="2" style="text-align: left;"><b>Ricambi - Spare parts</b></th> </tr> </thead> <tbody> <tr> <td>Piedino - Polo mints</td> <td style="text-align: right;"><b>P163000200</b></td> </tr> <tr> <td>Raccordo- Plug 8mm</td> <td style="text-align: right;"><b>245100900</b></td> </tr> <tr> <td>Gomma - Top rubber</td> <td style="text-align: right;"><b>P271100300</b></td> </tr> <tr> <td>ORInferiore-Bottom</td> <td style="text-align: right;"><b>3110A2197</b></td> </tr> </tbody> </table>	<b>Ricambi - Spare parts</b>		Piedino - Polo mints	<b>P163000200</b>	Raccordo- Plug 8mm	<b>245100900</b>	Gomma - Top rubber	<b>P271100300</b>	ORInferiore-Bottom	<b>3110A2197</b>	
<b>Ricambi - Spare parts</b>											
Piedino - Polo mints	<b>P163000200</b>										
Raccordo- Plug 8mm	<b>245100900</b>										
Gomma - Top rubber	<b>P271100300</b>										
ORInferiore-Bottom	<b>3110A2197</b>										

Intermac

Via dell'Economia, 40  
61122 Pesaro PU - Italy  
Tel. +39 0721 483500  
Fax +39 0721 481962  
www.intermac.com  
intermac.parts@intermac.com



<p><b>DIAMETRO 90MM</b> <b>DIAMETER 90MM</b></p> <table border="1"> <tr> <td colspan="2"><b>Ricambi - Spare parts</b></td> </tr> <tr> <td>Disco appoggio Disc support</td> <td><b>P1614P0037</b></td> </tr> <tr> <td>Gomma - Rubber</td> <td><b>P1453P0011</b></td> </tr> <tr> <td>Raccordo-Plug 8mm</td> <td><b>245100900</b></td> </tr> </table>	<b>Ricambi - Spare parts</b>		Disco appoggio Disc support	<b>P1614P0037</b>	Gomma - Rubber	<b>P1453P0011</b>	Raccordo-Plug 8mm	<b>245100900</b>	
<b>Ricambi - Spare parts</b>									
Disco appoggio Disc support	<b>P1614P0037</b>								
Gomma - Rubber	<b>P1453P0011</b>								
Raccordo-Plug 8mm	<b>245100900</b>								
<p><b>DIAMETRO 120MM</b> <b>DIAMETER 120MM</b></p> <table border="1"> <tr> <td colspan="2"><b>Ricambi - Spare parts</b></td> </tr> <tr> <td>Disco appoggio Disc support</td> <td><b>P1614P0036</b></td> </tr> <tr> <td>Gomma - Rubber</td> <td><b>P1453P0009</b></td> </tr> <tr> <td>Raccordo-Plug 8mm</td> <td><b>245100900</b></td> </tr> </table>	<b>Ricambi - Spare parts</b>		Disco appoggio Disc support	<b>P1614P0036</b>	Gomma - Rubber	<b>P1453P0009</b>	Raccordo-Plug 8mm	<b>245100900</b>	
<b>Ricambi - Spare parts</b>									
Disco appoggio Disc support	<b>P1614P0036</b>								
Gomma - Rubber	<b>P1453P0009</b>								
Raccordo-Plug 8mm	<b>245100900</b>								
<p><b>DIAMETRO 160MM</b> <b>DIAMETER 160MM</b></p> <table border="1"> <tr> <td colspan="2"><b>Ricambi - Spare parts</b></td> </tr> <tr> <td>Disco appoggio Disc support</td> <td><b>P1614P0035</b></td> </tr> <tr> <td>Gomma - Rubber</td> <td><b>P1453P0010</b></td> </tr> <tr> <td>Raccordo-Plug 8mm</td> <td><b>245100900</b></td> </tr> </table>	<b>Ricambi - Spare parts</b>		Disco appoggio Disc support	<b>P1614P0035</b>	Gomma - Rubber	<b>P1453P0010</b>	Raccordo-Plug 8mm	<b>245100900</b>	
<b>Ricambi - Spare parts</b>									
Disco appoggio Disc support	<b>P1614P0035</b>								
Gomma - Rubber	<b>P1453P0010</b>								
Raccordo-Plug 8mm	<b>245100900</b>								

**Intermac**

Via dell'Economia, 40  
61122 Pesaro PU - Italy  
Tel. +39 0721 483500  
Fax +39 0721 481962  
www.intermac.com  
intermac.parts@intermac.com



**TUBI PER VENTOSE / BATTUTE  
PIPES FOR SUCTION CUPS / BACKSTOPS**

<b>CODICE CODE</b>	<b>DESCRIZIONE DESCRIPTION</b>
<b>2407A0026</b>	6 x 8 BIANCO - WHITE PIPE
<b>240603300</b>	6 x 8 NERO - BLACK PIPE
<b>240601200</b>	6 x 8 BLU - BLUE PIPE
<b>240601100</b>	6 x 8 ROSSO - RED PIPE
<b>2406A0287</b>	6 x 8 GIALLO - YELLOW PIPE
<b>Q.tà minima 100mt - minimum q.ty 100mt</b>	

**Intermac**

Via dell'Economia, 40  
61122 Pesaro PU - Italy  
Tel. +39 0721 483500  
Fax +39 0721 481962  
www.intermac.com  
intermac.parts@intermac.com



**BATTUTE - BACKSTOPS**
**BATTUTA CON FISSAGGIO MECCANICO  
BACKSTOP UNIT MECHANICAL  
FIXING**

Altezza - Height 105	<b>P611800510</b>
Altezza - Height 213	<b>P630700500</b>
<b>Ricambi-Spare parts</b>	
Rondella teflon D26 plastic ring D26	<b>P140400210</b>
Rondella teflon D40 plastic ring D40	<b>P140412700</b>
Gruppo Nasello - Brass Tee Nut	<b>P751003500</b>

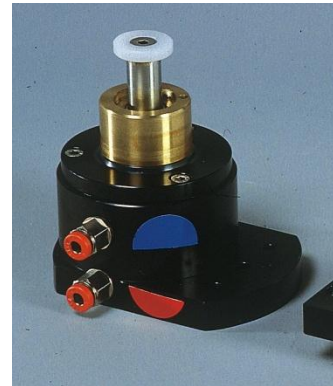
**BATTUTA CON FISSAGGIO VUOTO  
BACKSTOP UNIT VACUUM  
FIXING**

Altezza - Height 105	<b>P6307P0062</b>
Altezza - Height 150	<b>P6307P0063</b>
Altezza - Height 213	<b>P6307P0045</b>
<b>Ricambi-Spare parts</b>	
Rondella teflon D26 plastic ring D26	<b>P140400210</b>
Rondella teflon D40 plastic ring D40	<b>P140412700</b>
OR(Bottom) x H105 - H150	<b>3110A1926</b>
OR(Bottom) x H213	<b>3110A1923</b>

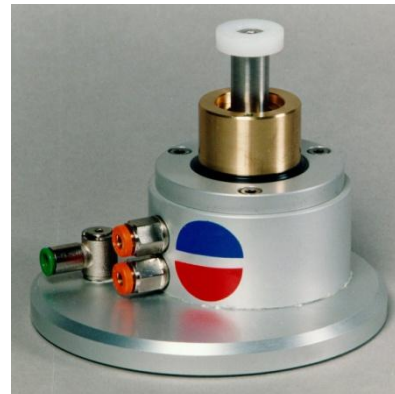
**BATTUTA CON FISSAGGIO MECCANICO + PROLUNGA  
BACKSTOP UNIT MECHANICAL  
FIXING + EXTENSION**

Altezza - Height 105	<b>P611801110</b>
Altezza - Height 213	<b>P630700400</b>
<b>Ricambi-Spare parts</b>	
Rondella teflon D26 plastic ring D26	<b>P140400210</b>
Rondella teflon D40 plastic ring D40	<b>P140412700</b>
Gruppo Nasello - Brass Tee Nut	<b>P751003500</b>



Intermac

Via dell'Economia, 40  
61122 Pesaro PU - Italy  
Tel. +39 0721 483500  
Fax +39 0721 481962  
www.Intermac.com  
intermac.parts@intermac.com



**ACCOSTATORE A SPINGERE  
RETRACTABLE PUSHER 0° - 90°**

Altezza - Height 105	<b>P6307P0011</b>
Altezza - Height 150	<b>P6307P0037</b>
Altezza - Height 213	<b>P6307P0039</b>
<b>Ricambi - Spare Parts</b>	
Rullo Teflon D22 Plastic Ring D22	<b>P1422P0022</b>

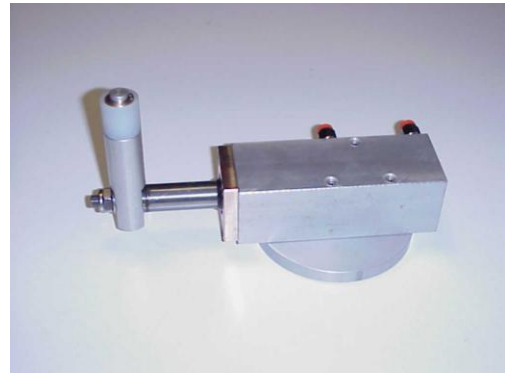
**ACCOSTATORE A TIRARE  
RETRACTABLE PULLER 0° - 90°**

Altezza - Height 105	<b>P6307P0047</b>
Altezza - Height 150	<b>P6307P0048</b>
Altezza - Height 213	<b>P6307P0041</b>
<b>Ricambi - Spare Parts</b>	
Rullo Teflon D22 Plastic Ring D22	<b>P1422P0022</b>

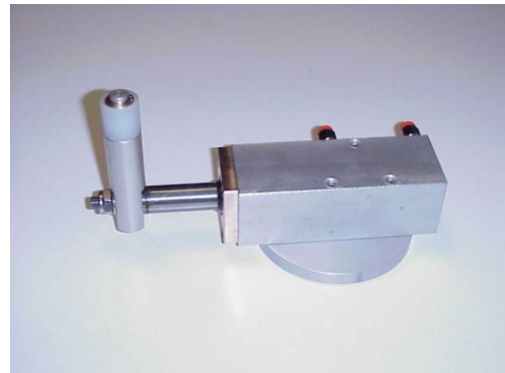
**Battuta circolare per incisioni  
su piano macchina  
Flat round reference stop  
for engraving**

Codice - Code	<b>P6307P0038</b>
<b>Ricambi - Spare Parts</b>	
PCV stop	<b>P1408P0031</b>

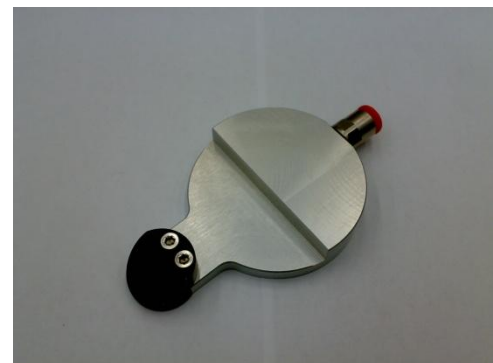
**Battuta a L per incisioni su  
piano macchina  
Flat L-shape reference stop  
for engraving**

Codice - Code	<b>P6307P0036</b>
<b>Ricambi - Spare Parts</b>	
TEFLON stop	<b>P1408P0030</b>









<p><b>BATTUTA PER INCISIONE BACKSTOP FOR ENGRAVING</b></p> <table border="1" data-bbox="236 383 767 421"><tr><td>Codice - Code</td><td><b>P6390P0463</b></td></tr></table>	Codice - Code	<b>P6390P0463</b>	
Codice - Code	<b>P6390P0463</b>		
<p><b>BATTUTA PER INCISIONE A "T" BACKSTOP FOR ENGRAVING "T"</b></p> <table border="1" data-bbox="236 736 767 775"><tr><td>Codice - Code</td><td><b>P6390P0461</b></td></tr></table>	Codice - Code	<b>P6390P0461</b>	
Codice - Code	<b>P6390P0461</b>		
<p><b>BATTUTA PER INCISIONE LUNGA BACKSTOP FOR ENGRAVING STRAIGHT</b></p> <table border="1" data-bbox="236 1126 767 1164"><tr><td>Codice - Code</td><td><b>P6390P0462</b></td></tr></table>	Codice - Code	<b>P6390P0462</b>	
Codice - Code	<b>P6390P0462</b>		

**Intermac**

Via dell'Economia, 40  
61122 Pesaro PU - Italy  
Tel. +39 0721 483500  
Fax +39 0721 481962  
www.intermac.com  
intermac.parts@intermac.com



## RICAMBI PER BATTUTE - SPARE PARTS FOR BACKSTOPS

<p><b>BATTUTA IN TEFLON std+speciali</b> <b>RING x BACKSTOPS std + special</b></p> <table border="1"> <tbody> <tr> <td>Diameter 26mm</td> <td><b>P140400210</b></td> </tr> <tr> <td>Diameter 26mm x backstop h105mm</td> <td><b>P1404P0036</b></td> </tr> <tr> <td>Diameter 40mm</td> <td><b>P140412700</b></td> </tr> <tr> <td>Diameter 75mm</td> <td><b>P140400300</b></td> </tr> <tr> <td>Diameter 105mm</td> <td><b>FNX0150411</b></td> </tr> </tbody> </table>	Diameter 26mm	<b>P140400210</b>	Diameter 26mm x backstop h105mm	<b>P1404P0036</b>	Diameter 40mm	<b>P140412700</b>	Diameter 75mm	<b>P140400300</b>	Diameter 105mm	<b>FNX0150411</b>	
Diameter 26mm	<b>P140400210</b>										
Diameter 26mm x backstop h105mm	<b>P1404P0036</b>										
Diameter 40mm	<b>P140412700</b>										
Diameter 75mm	<b>P140400300</b>										
Diameter 105mm	<b>FNX0150411</b>										
<p><b>CILINDRO PER PISTONE</b> <b>CYLINDER FOR PISTON</b></p> <table border="1"> <tbody> <tr> <td>Codice - Code</td> <td><b>P0925P0091</b></td> </tr> </tbody> </table>	Codice - Code	<b>P0925P0091</b>									
Codice - Code	<b>P0925P0091</b>										
<p><b>PISTONE IN ACCIAIO</b> <b>IRON PISTON</b></p> <table border="1"> <tbody> <tr> <td>Codice - Code</td> <td><b>P081502300</b></td> </tr> </tbody> </table>	Codice - Code	<b>P081502300</b>									
Codice - Code	<b>P081502300</b>										
<p><b>KIT GUARNIZIONI PER BATTUTE</b> <b>KIT ORINGSAND SEAL FOR</b> <b>BACKSTOP</b></p> <table border="1"> <tbody> <tr> <td>Codice - Code</td> <td><b>P751009200</b></td> </tr> </tbody> </table>	Codice - Code	<b>P751009200</b>									
Codice - Code	<b>P751009200</b>										

Intermac

Via dell'Economia, 40  
61122 Pesaro PU - Italy  
Tel. +39 0721 483500  
Fax +39 0721 481962  
www.intermac.com  
intermac.parts@intermac.com



## MORSETTI - CLAMP

**Morsetti meccanici con fissaggio tramite vuoto**  
**Mechanical clamp with vacuum fixing.**

Altezza - Height 105	<b>P6301P0015</b>
Altezza - Height 150	<b>P6301P0017</b>
Altezza - Height 213	<b>P6301P0016</b>

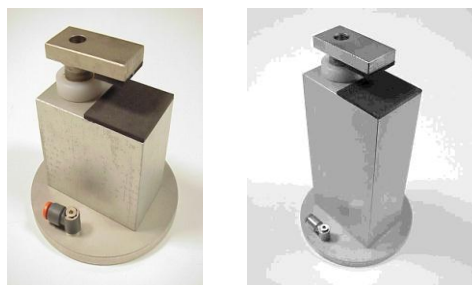

**Morsetti pneumatici con fissaggio tramite vuoto**  
**Pneumatic clamp with vacuum fixing.**

Altezza - Height 105	<b>P6301P0009</b>
Altezza - Height 150	<b>P6301P0010</b>
Altezza - Height 213	<b>P6301P0011</b>



## RICAMBI PER MORSETTI - SPARE PARTS FOR CLAMP

**RACCORDI ARIA/VUOTO**  
**AIR CONNECTOR**

6 mm	<b>245100700</b>
8 mm	<b>245100900</b>



**PIEDINI DI APPOGGIO**  
**POLO MINTS**

Codice - Code	<b>P163000200</b>
---------------	-------------------



Intermac

Via dell'Economia, 40  
 61122 Pesaro PU - Italy  
 Tel. +39 0721 483500  
 Fax +39 0721 481962  
 www.intermac.com  
 intermac.parts@intermac.com



## GRUPPI FILTRI - FILTERS

### Filtri disoleatore/Condensa Oil/water Filters

Verde/Green D40 L120mm	<b>2422A0204</b>
Verde/Green D22 L50mm	<b>2422A0205</b>
Bianco/White 20µ D30 L35mm	<b>2422A0207</b>
Bianco/White 50µ D16 L27mm	<b>2422A0209</b>
Bianco/White 50µ D30 L35mm	<b>2422A0224</b>



### FILTRI ACQUA -WATER FILTERS

Gruppo completo da due unità Complete water filter unit	<b>P636500100</b>
Filtro 10 microns	<b>2422A0135</b>
Filtro 5 microns ceramico	<b>2422A0136</b>

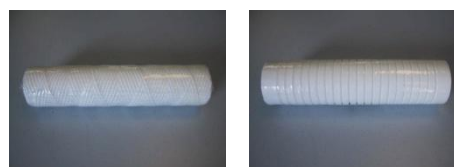

**(10 microns)**

**(5 microns)**

### Filtri Metallici Per Vasca Alluminium Water Filters

Filtro da 1" ¼ Filter 1" ¼ <b>(1)</b>	<b>2422A0140</b>
Filtro da 2" ½ Filter 2" ½ <b>(2)</b>	<b>2422A0141</b>
Filtro da 3" Filter 3"	<b>2422A0168</b>



**2**

**1**

Intermac

Via dell'Economia, 40  
61122 Pesaro PU - Italy  
Tel. +39 0721 483500  
Fax +39 0721 481962  
www.intermac.com  
intermac.parts@intermac.com



## RACCORDI PER ARIA E ACQUA AIR AND WATER CONNECTORS

<p><b>RACCORDI ARIA PER RUBINETTI AIR CONNECTORS FOR TAPS</b></p> <table border="1" style="width: 100%; border-collapse: collapse;"> <tr> <td style="padding: 2px;">6 mm (Pos 2)</td> <td style="padding: 2px;"><b>245128500</b></td> </tr> <tr> <td style="padding: 2px;">8 mm (Pos 2)</td> <td style="padding: 2px;"><b>245128600</b></td> </tr> <tr> <td style="padding: 2px;">8 mm (Pos 1)</td> <td style="padding: 2px;"><b>2451A3060</b></td> </tr> <tr> <td style="padding: 2px;">Innesto Rapido</td> <td style="padding: 2px;"><b>245108900</b></td> </tr> </table>	6 mm (Pos 2)	<b>245128500</b>	8 mm (Pos 2)	<b>245128600</b>	8 mm (Pos 1)	<b>2451A3060</b>	Innesto Rapido	<b>245108900</b>	<div style="display: flex; justify-content: space-around;"> <div style="text-align: center;"> <p><b>1</b></p>  </div> <div style="text-align: center;"> <p><b>2</b></p>  </div> </div> <div style="text-align: center; margin-top: 20px;">  </div>				
6 mm (Pos 2)	<b>245128500</b>												
8 mm (Pos 2)	<b>245128600</b>												
8 mm (Pos 1)	<b>2451A3060</b>												
Innesto Rapido	<b>245108900</b>												
<p><b>RACCORDO A "Y" PER VENTOSE "Y" AIR CONNECTOR FOR SUCTION CUPS</b></p> <table border="1" style="width: 100%; border-collapse: collapse;"> <tr> <td style="padding: 2px;">6 mm</td> <td style="padding: 2px;"><b>2450A3024</b></td> </tr> <tr> <td style="padding: 2px;">8 mm</td> <td style="padding: 2px;"><b>2450A3025</b></td> </tr> </table>	6 mm	<b>2450A3024</b>	8 mm	<b>2450A3025</b>	<div style="text-align: center;">  </div>								
6 mm	<b>2450A3024</b>												
8 mm	<b>2450A3025</b>												
<p style="text-align: center;"><b>Ugelli Acqua - Water Nozzle</b></p> <table border="1" style="width: 100%; border-collapse: collapse;"> <tr> <td style="padding: 2px;">Pos.1</td> <td style="padding: 2px;">1/4 Gas</td> <td style="padding: 2px;"><b>2443A0058</b></td> </tr> <tr> <td style="padding: 2px;">Pos.1</td> <td style="padding: 2px;">1/8 Gas</td> <td style="padding: 2px;"><b>2450A3940</b></td> </tr> <tr> <td style="padding: 2px;">Pos.2</td> <td style="padding: 2px;">Tubo flessibile</td> <td style="padding: 2px;"><b>2450A3902</b></td> </tr> <tr> <td style="padding: 2px;">Pos.3</td> <td style="padding: 2px;">Terminale</td> <td style="padding: 2px;"><b>2450A3847</b></td> </tr> </table>	Pos.1	1/4 Gas	<b>2443A0058</b>	Pos.1	1/8 Gas	<b>2450A3940</b>	Pos.2	Tubo flessibile	<b>2450A3902</b>	Pos.3	Terminale	<b>2450A3847</b>	<div style="text-align: center;">  </div>
Pos.1	1/4 Gas	<b>2443A0058</b>											
Pos.1	1/8 Gas	<b>2450A3940</b>											
Pos.2	Tubo flessibile	<b>2450A3902</b>											
Pos.3	Terminale	<b>2450A3847</b>											
<p style="text-align: center;"><b>Ugelli Acqua - Water Nozzle Master Groove / Master 34.</b></p> <table border="1" style="width: 100%; border-collapse: collapse;"> <tr> <td style="padding: 2px;">Pos.1</td> <td style="padding: 2px;">3/8 Gas</td> <td style="padding: 2px;"><b>2450A3939</b></td> </tr> <tr> <td style="padding: 2px;">Pos.2</td> <td style="padding: 2px;">Tubo flessibile</td> <td style="padding: 2px;"><b>2450A3901</b></td> </tr> <tr> <td style="padding: 2px;">Pos.3</td> <td style="padding: 2px;">Terminale</td> <td style="padding: 2px;"><b>2450A4058</b></td> </tr> </table>	Pos.1	3/8 Gas	<b>2450A3939</b>	Pos.2	Tubo flessibile	<b>2450A3901</b>	Pos.3	Terminale	<b>2450A4058</b>	<div style="text-align: center;">  </div>			
Pos.1	3/8 Gas	<b>2450A3939</b>											
Pos.2	Tubo flessibile	<b>2450A3901</b>											
Pos.3	Terminale	<b>2450A4058</b>											

Intermac

Via dell'Economia, 40  
61122 Pesaro PU - Italy  
Tel. +39 0721 483500  
Fax +39 0721 481962  
www.intermac.com  
intermac.parts@intermac.com





## VALVOLE A TAMPONE - VALVES

### VALVOLE A TAMPONE VACUUM / WATER VALVES

Valv. 3/8	<b>P230400700</b>
Valv. 1"	<b>P2413P0011</b>
Valv. 3/4	<b>P241700100</b>



## RUBINETTI - TAPS

### RUBINETTI - MANIFOLD TAPS

Rosso - Red	<b>2415A0022</b>
Nero - Black	<b>2415A0023</b>
Giallo - Yellow	<b>2415A0024</b>
Bianco - White -Iron	<b>2415A0025</b>
Blu - Blue	<b>2415A0026</b>



### Distributore a Ragno Circular pneumatic distributor with vacuum fixing.

Codice - Code	<b>P6329P0009</b>
---------------	-------------------



Intermac

Via dell'Economia, 40  
61122 Pesaro PU - Italy  
Tel. +39 0721 483500  
Fax +39 0721 481962  
www.intermac.com  
intermac.parts@intermac.com



## Cavi e sensori vari – Cables and Sensors

<p><b>Cavo per sensori mandrino Master Sensor cable for Master Line</b></p> <table border="1"> <tr> <td>L=0,30mt</td> <td><b>6480A0208</b></td> </tr> <tr> <td>L= 1mt</td> <td><b>6480A0129</b></td> </tr> </table>	L=0,30mt	<b>6480A0208</b>	L= 1mt	<b>6480A0129</b>	
L=0,30mt	<b>6480A0208</b>				
L= 1mt	<b>6480A0129</b>				
<p><b>Sensore mandrino per Master Sensor for Master Line Mod.Normally Closed X ES796 only FCMP (1pc)</b></p> <table border="1"> <tr> <td>Vecchio tipo (lungo) Old Type (long)</td> <td><b>H5664H0046</b></td> </tr> <tr> <td>Nuovo Tipo (corto) New Type (short)</td> <td><b>H5664H0062</b></td> </tr> </table>	Vecchio tipo (lungo) Old Type (long)	<b>H5664H0046</b>	Nuovo Tipo (corto) New Type (short)	<b>H5664H0062</b>	
Vecchio tipo (lungo) Old Type (long)	<b>H5664H0046</b>				
Nuovo Tipo (corto) New Type (short)	<b>H5664H0062</b>				
<p><b>Sensore mandrino per Master Sensor for Master Line Mod.Normally Open</b></p> <table border="1"> <tr> <td>Codice - Code</td> <td><b>H5664H0040</b></td> </tr> </table>	Codice - Code	<b>H5664H0040</b>			
Codice - Code	<b>H5664H0040</b>				
<p><b>SENSORE MANDRINO CON CAVO E CONNETTORE 3PIN SENSOR AND CABLE ASSEMBLY WITH CONNECTOR 3PIN <i>JET / PRO SERIES</i></b></p> <table border="1"> <tr> <td>Codice - Code</td> <td><b>P6390P0100</b></td> </tr> </table>	Codice - Code	<b>P6390P0100</b>			
Codice - Code	<b>P6390P0100</b>				
<p><b>SENSORE MANDRINO CON CAVO SENSOR AND CABLE ASSEMBLY MACCHINE VECCHIE – OLD MC</b></p> <table border="1"> <tr> <td>Codice - Code</td> <td><b>H4180500302</b></td> </tr> </table>	Codice - Code	<b>H4180500302</b>			
Codice - Code	<b>H4180500302</b>				



Intermac

Via dell'Economia, 40  
61122 Pesaro PU - Italy  
Tel. +39 0721 483500  
Fax +39 0721 481962  
www.intermac.com  
intermac.parts@intermac.com



<p><b>SENSORE MAGNETICO</b> <b>MAGNETIC SENSOR - 3 pins</b></p> <table border="1"> <tr> <td>Sensor - Sensor</td> <td><b>P2164P0074</b></td> </tr> <tr> <td>Cavo - Cable (4 Mt.)</td> <td><b>6480A0171</b></td> </tr> </table>	Sensor - Sensor	<b>P2164P0074</b>	Cavo - Cable (4 Mt.)	<b>6480A0171</b>			
Sensor - Sensor	<b>P2164P0074</b>						
Cavo - Cable (4 Mt.)	<b>6480A0171</b>						
<p><b>SENSORE MAGNETICO</b> <b>MAGNETIC SENSOR - 2 pins</b></p> <table border="1"> <tr> <td>Sensore - Sensor</td> <td><b>2164A0171</b></td> </tr> <tr> <td>Con Cavo (2.5 Mt.) With Cable (2.5 Mt.)</td> <td><b>2164A0080</b></td> </tr> <tr> <td>Con Cavo (10 Mt.) With Cable (10 Mt.)</td> <td><b>P2164P0015</b></td> </tr> </table>	Sensore - Sensor	<b>2164A0171</b>	Con Cavo (2.5 Mt.) With Cable (2.5 Mt.)	<b>2164A0080</b>	Con Cavo (10 Mt.) With Cable (10 Mt.)	<b>P2164P0015</b>	
Sensore - Sensor	<b>2164A0171</b>						
Con Cavo (2.5 Mt.) With Cable (2.5 Mt.)	<b>2164A0080</b>						
Con Cavo (10 Mt.) With Cable (10 Mt.)	<b>P2164P0015</b>						
<p><b>Sensore PROXIMITY M08</b> <b>(Siemens)</b></p> <table border="1"> <tr> <td>Sensore - Sensor</td> <td><b>P216400800</b></td> </tr> <tr> <td>Cavo - Cable</td> <td><b>P216400900</b></td> </tr> </table>	Sensore - Sensor	<b>P216400800</b>	Cavo - Cable	<b>P216400900</b>			
Sensore - Sensor	<b>P216400800</b>						
Cavo - Cable	<b>P216400900</b>						
<p><b>Sensore presenza utensile</b> <b>Tool presence sensor</b></p> <table border="1"> <tr> <td>WT250 P460 SICK</td> <td><b>P2164P0028</b></td> </tr> <tr> <td>WT170 P430 SICK</td> <td><b>P2164P0027</b></td> </tr> </table>	WT250 P460 SICK	<b>P2164P0028</b>	WT170 P430 SICK	<b>P2164P0027</b>			
WT250 P460 SICK	<b>P2164P0028</b>						
WT170 P430 SICK	<b>P2164P0027</b>						
<p><b>FIBRA OTTICA - OPTICAL FIBRE</b> <b>FU-35FA</b></p> <table border="1"> <tr> <td>Codice - Code</td> <td><b>P2164P0041</b></td> </tr> </table> <p><b>AMPLIFICATORE - AMPLIFIER</b> <b>KEYENCE FS2-60P</b></p> <table border="1"> <tr> <td>Codice - Code</td> <td><b>P2164P0042</b></td> </tr> </table> <p><b>LENTE PER FIBRA OTTICA</b> <b>LENS for OPTICAL FIBRE</b></p> <table border="1"> <tr> <td>Codice - Code</td> <td><b>P2164P0043</b></td> </tr> </table>	Codice - Code	<b>P2164P0041</b>	Codice - Code	<b>P2164P0042</b>	Codice - Code	<b>P2164P0043</b>	
Codice - Code	<b>P2164P0041</b>						
Codice - Code	<b>P2164P0042</b>						
Codice - Code	<b>P2164P0043</b>						

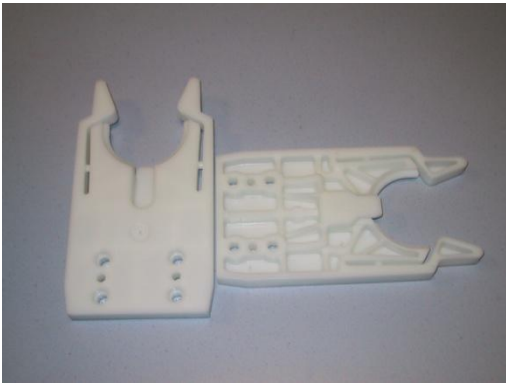

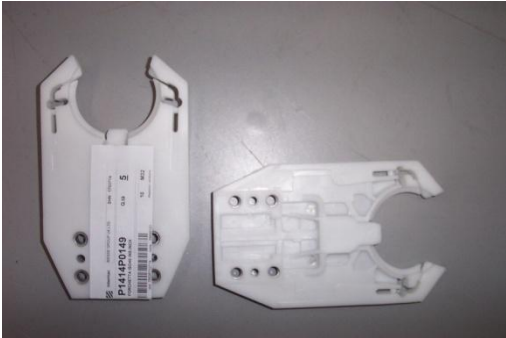
**FORCHETTE - TOOL FORKS**

<p><b>FORCHETTE ISO40 PVC BIANCO TOOL FORK ISO 40 WHITE PVC</b></p> <table border="1" data-bbox="236 517 767 555"> <tr> <td>Codice - Code</td> <td><b>P1414P0030</b></td> </tr> </table>	Codice - Code	<b>P1414P0030</b>	
Codice - Code	<b>P1414P0030</b>		
<p><b>FORCHETTE ISO40 PVC NERO RINFORZATE TOOL FORK ISO 40 BLACK PVC REINFORCED</b></p> <table border="1" data-bbox="236 1003 767 1041"> <tr> <td>Codice - Code</td> <td><b>P6302P0002</b></td> </tr> </table>	Codice - Code	<b>P6302P0002</b>	
Codice - Code	<b>P6302P0002</b>		
<p><b>FORCHETTE ISO40 IN OTTONE TOOL FORK ISO 40 - BRASS</b></p> <table border="1" data-bbox="236 1279 767 1317"> <tr> <td>Codice - Code</td> <td><b>P615500300</b></td> </tr> </table>	Codice - Code	<b>P615500300</b>	
Codice - Code	<b>P615500300</b>		
<p><b>FORCHETTE ISO40 PVC BIANCO RINFORZATE PER NUOVE MASTER TOOL FORK ISO 40 WHITE PVC REINFORCED (NEW MASTER)</b></p> <table border="1" data-bbox="236 1727 767 1765"> <tr> <td>Codice - Code</td> <td><b>P1414P0149</b></td> </tr> </table>	Codice - Code	<b>P1414P0149</b>	
Codice - Code	<b>P1414P0149</b>		

Intermac

Via dell'Economia, 40  
61122 Pesaro PU - Italy  
Tel. +39 0721 483500  
Fax +39 0721 481962  
www.intermac.com  
intermac.parts@intermac.com



<p><b>FORCHETTE ISO40 PVC NERO RINFORZATE PER AGGREGATI TOOL FORK ISO 40 BLACK PVC REINFORCED For Aggregate</b></p> <table border="1" data-bbox="236 427 767 461"> <tr> <td>Codice - Code</td> <td><b>P6302P0008</b></td> </tr> </table>	Codice - Code	<b>P6302P0008</b>			
Codice - Code	<b>P6302P0008</b>				
<p><b>FORCHETTE ISO30 ALLUMINIO TOOL FORK ISO 30 ALLUMINIUM</b></p> <table border="1" data-bbox="236 741 767 938"> <tr> <td>Master Groove Master34 (senza nottolino-no spring)</td> <td><b>P615500100</b></td> </tr> <tr> <td>Master Edge ISO 30 (con nottolino - with spring)</td> <td><b>P615500200</b></td> </tr> </table>	Master Groove Master34 (senza nottolino-no spring)	<b>P615500100</b>	Master Edge ISO 30 (con nottolino - with spring)	<b>P615500200</b>	
Master Groove Master34 (senza nottolino-no spring)	<b>P615500100</b>				
Master Edge ISO 30 (con nottolino - with spring)	<b>P615500200</b>				
<p><b>NOTTOLINO PER FORCHETTE METALLICHE SPRING FOR METAL TOOL HOLDER</b></p> <table border="1" data-bbox="236 1205 767 1238"> <tr> <td>ISO40 - ISO30</td> <td><b>P751016900</b></td> </tr> </table>	ISO40 - ISO30	<b>P751016900</b>			
ISO40 - ISO30	<b>P751016900</b>				

Intermac

Via dell'Economia, 40  
61122 Pesaro PU - Italy  
Tel. +39 0721 483500  
Fax +39 0721 481962  
www.intermac.com  
intermac.parts@intermac.com





**RICAMBI PER ELETTROMANDRINI – vedi comunicazioni**  
**SPARE PARTS FOR ELECTROSPINDLE – see newsletter**

<p><b>LETTORE ENCODER ENCODER LENS ES710-ES721-ES760</b></p> <table border="1"> <tr> <td>Codice – Code</td> <td><b>H0306D0033</b></td> </tr> </table>	Codice – Code	<b>H0306D0033</b>					
Codice – Code	<b>H0306D0033</b>						
<p><b>SCHEDA INTERFACCIA ENCODER ENCODER PCB CARD ES710-ES721-ES760</b></p> <table border="1"> <tr> <td>Codice - Code</td> <td><b>H0101D058C</b></td> </tr> </table>	Codice - Code	<b>H0101D058C</b>					
Codice - Code	<b>H0101D058C</b>						
<p><b>ENCODER OTTICO VECCHIE MASTER OPTICAL ENCODER OLD MASTER ES790-ES796</b></p> <table border="1"> <tr> <td>ES790/ES796 - ENCODER</td> <td><b>H0113D0059C2</b></td> </tr> <tr> <td>ES790 – DISK</td> <td><b>H2211H0003</b></td> </tr> <tr> <td>ES796 - DISK</td> <td><b>H2211H0047</b></td> </tr> </table>	ES790/ES796 - ENCODER	<b>H0113D0059C2</b>	ES790 – DISK	<b>H2211H0003</b>	ES796 - DISK	<b>H2211H0047</b>	
ES790/ES796 - ENCODER	<b>H0113D0059C2</b>						
ES790 – DISK	<b>H2211H0003</b>						
ES796 - DISK	<b>H2211H0047</b>						
<p><b>GRUPPO PINZA MANDRINO KIT for ELECTROSPINDLE CLAMP</b> (pinza, sfere, or) solo autorizzati (clamp, balls, or) only authorized</p> <table border="1"> <tr> <td>(ES710 – ES760)</td> <td><b>P6390P0298</b></td> </tr> <tr> <td>(ES721 – ES790 - ES791)</td> <td><b>P6390P0297</b></td> </tr> <tr> <td>(ES796 - ES793)</td> <td><b>H1738H0002</b></td> </tr> </table>	(ES710 – ES760)	<b>P6390P0298</b>	(ES721 – ES790 - ES791)	<b>P6390P0297</b>	(ES796 - ES793)	<b>H1738H0002</b>	
(ES710 – ES760)	<b>P6390P0298</b>						
(ES721 – ES790 - ES791)	<b>P6390P0297</b>						
(ES796 - ES793)	<b>H1738H0002</b>						
<p><b>RESOLVER ESTERNO EXTERNAL RESOLVER</b></p> <table border="1"> <tr> <td>Resolver</td> <td><b>P270801600</b></td> </tr> <tr> <td>Cinghia - Belt</td> <td><b>2701A0133</b></td> </tr> <tr> <td>Puleggia - Pulley</td> <td><b>P2704N0001</b></td> </tr> </table>	Resolver	<b>P270801600</b>	Cinghia - Belt	<b>2701A0133</b>	Puleggia - Pulley	<b>P2704N0001</b>	
Resolver	<b>P270801600</b>						
Cinghia - Belt	<b>2701A0133</b>						
Puleggia - Pulley	<b>P2704N0001</b>						

Intermac

Via dell'Economia, 40  
 61122 Pesaro PU - Italy  
 Tel. +39 0721 483500  
 Fax +39 0721 481962  
 www.Intermac.com  
 intermac.parts@intermac.com



## AGGREGATI - AGGREGATES

SOLO PER LA NUOVA LINEA MASTER

Tutti i codici elencati sono comprensivi di supporto ma senza utensile.

For new MASTER series – ONLY

All the codes are with support and without tool

**Aggregato a corpo basso per scrittura e foratura laterale.  
SOLO PER MACCHINE CON ASSEC**

**Short body aggregate for side writing and boring.  
ONLY FOR MACHINES WITH C  
AXIS**

3assi - 3axis	<b>P6390P0319</b>
---------------	-------------------



**Aggregato per incisione verticale, diam. max. 150mm, foro 30mm.  
SOLO PER MACCHINE CON ASSEC**

**Aggregate for vertical engraving, max diam.150 mm, hole 30 mm.  
ONLY FOR MACHINES WITH C  
AXIS**

3assi - 3axis	<b>P6390P0228</b>
5assi - 5axis	<b>P6390P0250</b>



**Aggregato ISO40 per mola a tazza e bisello oltre 45° (richiede attrezzatura alta 213mm).**

**ISO 40 support for cup wheel and bevelling over 45° (requires working table set up H213mm)**

3assi - 3axis	<b>P6390P0187</b>
5assi - 5axis	<b>P6390P0174</b>

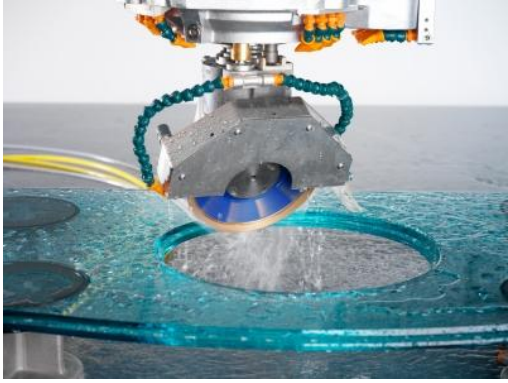
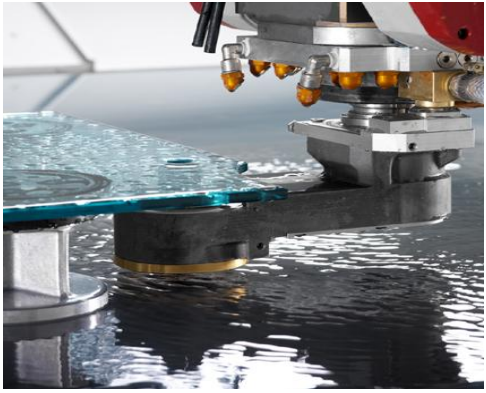
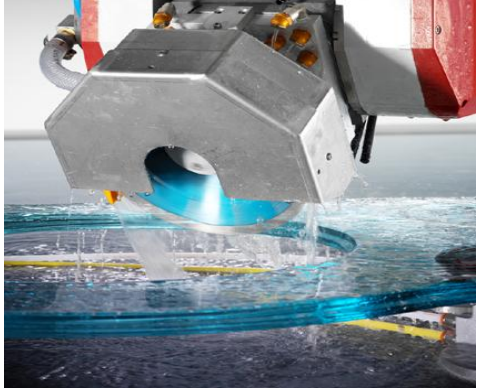
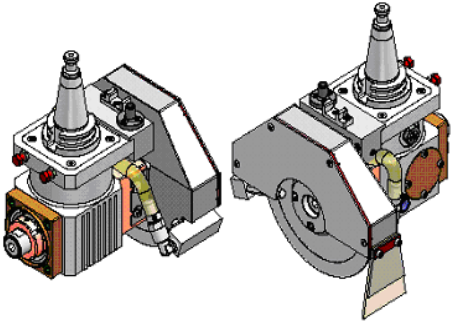

<p><b>Aggregato per tagli sagomati con disco bombato diametro max 180mm 30°, foro 30mm <u>SOLO PER MACCHINE CON ASSEC</u></b></p> <p><b>Aggregate used for profile cuts using a convex saw disc, inclination 30°, max disc 180mm, tool mounting hole 30 mm. <u>ONLY FOR MACHINES WITH C AXIS</u></b></p> <table border="1" data-bbox="236 600 767 645"> <tr> <td>3assi - 3axis</td> <td><b>P6390P0238</b></td> </tr> </table>	3assi - 3axis	<b>P6390P0238</b>							
3assi - 3axis	<b>P6390P0238</b>								
<p><b>Aggregato per foratura inferiore <u>SOLO PER MACCHINE CON ASSEC</u> <u>RICHIEDE FORETTI SPECIALI</u></b></p> <p><b>Bottom side drilling aggregate. <u>ONLY FOR C AXIS MACHINES</u> <u>REQUIRES SPECIAL DRILL</u></b></p> <table border="1" data-bbox="236 952 767 1086"> <tr> <td>3assi - 3axis</td> <td><b>P6390P0242</b></td> </tr> <tr> <td>5assi - 5axis</td> <td><b>P6390P0175</b></td> </tr> <tr> <td>H max ventose 180</td> <td></td> </tr> <tr> <td>H max Suction 180</td> <td></td> </tr> </table>	3assi - 3axis	<b>P6390P0242</b>	5assi - 5axis	<b>P6390P0175</b>	H max ventose 180		H max Suction 180		
3assi - 3axis	<b>P6390P0242</b>								
5assi - 5axis	<b>P6390P0175</b>								
H max ventose 180									
H max Suction 180									
<p><b>Aggregato per tagli sagomati con disco bombato diametro max 250mm , foro 30mm <u>SOLO PER MACCHINE 5 ASSI</u></b></p> <p><b>Support for profile cuts using a convex saw disc, max disc 250 mm, disc mounting hole 30 mm. <u>ONLY FOR MASTER 5 AXIS</u></b></p> <table border="1" data-bbox="236 1458 767 1503"> <tr> <td>3assi - 3axis</td> <td><b>P6390P0177</b></td> </tr> </table>	3assi - 3axis	<b>P6390P0177</b>							
3assi - 3axis	<b>P6390P0177</b>								
<p><b>Aggregato a due uscite per tagli lineari con disco dritto max diam200mm foro 30mm o scrittura laterale</b></p> <p><b>Aggregate used for straight cuts or side writing. Max disc 200mm, tool mounting hole 30 mm.</b></p> <table border="1" data-bbox="236 1816 767 1890"> <tr> <td>3assi - 3axis</td> <td><b>P6390P0236</b></td> </tr> <tr> <td>5assi - 5axis</td> <td><b>P6390P0416</b></td> </tr> </table>	3assi - 3axis	<b>P6390P0236</b>	5assi - 5axis	<b>P6390P0416</b>					
3assi - 3axis	<b>P6390P0236</b>								
5assi - 5axis	<b>P6390P0416</b>								



**Aggregato Incisione per Master30 con magazzino predisposto**

**Vertical engraving Aggregate for Master30 with configured loader**

3assi - 3axis

**P6314P0122**

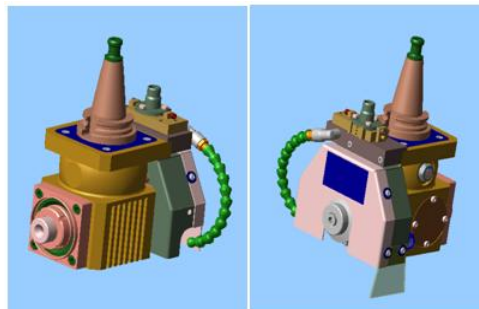

**Aggregato per tagli rettilinei con disco piatto diam max 350mm foro 50mm  
SOLO PER MASTER 5ASSI**

**Support for straight cuts with flat saw disc, maximum diameter 350mm, disc mounting hole 50 mm.**

**ONLY FOR MASTER 5AXIS**

5assi - 5axis

**P6390P0243**

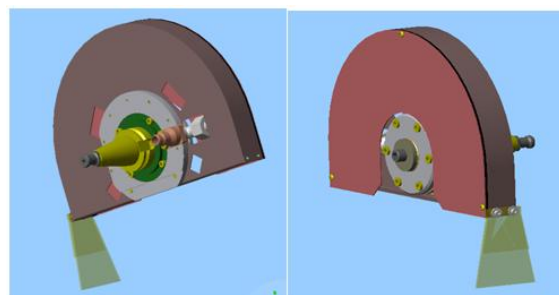

**Intermac**

Via dell'Economia, 40  
61122 Pesaro PU - Italy  
Tel. +39 0721 483500  
Fax +39 0721 481962  
www.intermac.com  
intermac.parts@intermac.com



## PRESETTERS

### PRESETTER MECCANICO MECHANICAL PRESETTER

Presetter utensili meccanico a bordo macchina H105mm

Mechanical tool presetter h105mm

MASTER 3 ax+ 5 ax	<b>P6390P0373</b>
MASTER 30 only	<b>P6390P0437</b>
MASTER 23 only	<b>P6390P0438</b>
MASTER 34 only	<b>KR35200292</b>
<b>Ricambi – Spare Parts</b>	
Spina di rottura Braking Pin	<b>2164A0832</b>
Disco - Plate	<b>FNX0150113</b>

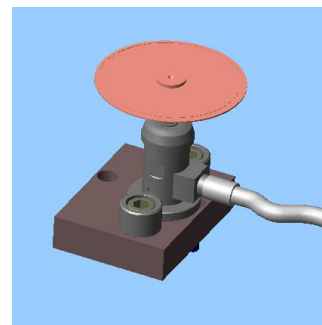

### PRESETTER DIGITALE

Presetter utensili mediante un sistema ottico fissato sul lato dell'armadio elettrico

Tool presetter using a visual system located alongside the electric cabinet.

Codice - Code	<b>P6390P0171</b>
---------------	-------------------





#### Intermac

Via dell'Economia, 40  
61122 Pesaro PU - Italy  
Tel. +39 0721 483500  
Fax +39 0721 481962  
www.intermac.com  
intermac.parts@intermac.com



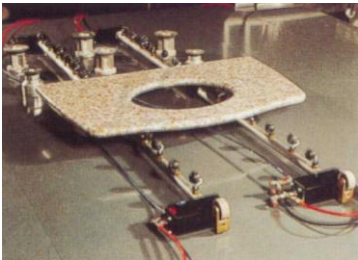
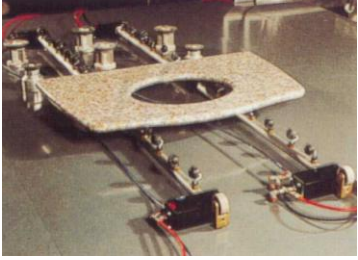

**ACCESSORI SPECIALI - SPECIAL EQUIPMENT**

<p><b>Coppia di rulliere per posizionamento lastre Fissaggio con vuoto Lunghezza 1500mm Altezza 105mm</b></p> <p><b>Rollers for sheet positioning. Length 1500 mm. Height 105 mm.</b></p> <table border="1" data-bbox="236 674 767 707"> <tr> <td>Codice - Code</td> <td><b>P6303P0071</b></td> </tr> </table>	Codice - Code	<b>P6303P0071</b>			
Codice - Code	<b>P6303P0071</b>				
<p><b>Coppia di rulliere per posizionamento lastre Fissaggio con vuoto Lunghezza 2300mm Altezza 105mm</b></p> <p><b>Rollers for sheet positioning. Length 2300 mm. Height 105 mm.</b></p> <table border="1" data-bbox="236 1059 767 1126"> <tr> <td>H105</td> <td><b>P6303P0007</b></td> </tr> <tr> <td>H213</td> <td><b>P6303P0010</b></td> </tr> </table>	H105	<b>P6303P0007</b>	H213	<b>P6303P0010</b>	
H105	<b>P6303P0007</b>				
H213	<b>P6303P0010</b>				
<p><b>Pompa pneumatica per il rifornimento del serbatoio automatico del grasso</b></p> <p><b>Compressed air pump kit for filling the grease reservoir of the automatic greaser.</b></p> <table border="1" data-bbox="236 1435 767 1469"> <tr> <td>Codice - Code</td> <td><b>P6320P0005</b></td> </tr> </table>	Codice - Code	<b>P6320P0005</b>			
Codice - Code	<b>P6320P0005</b>				
<p><b>Fresa per rettifica ventose e piano di lavoro in gomma</b></p> <p><b>Blue cup wheel for grinding suction cups and rubber bed</b></p> <table border="1" data-bbox="236 1753 767 1787"> <tr> <td>Codice - Code</td> <td><b>P1425P0003</b></td> </tr> </table>	Codice - Code	<b>P1425P0003</b>			
Codice - Code	<b>P1425P0003</b>				





**RAVVIVA UTENSILI - DRESSING DEVICES**
**Ravviva foretto h105mm**
**Drilling bit dresser h105 mm**

MASTER 3 ax+ 5 ax	<b>P6314P0005</b>
Master 30 only	<b>P6314P0083</b>
<b>Ricambi - Spare Parts</b>	
Ravvivatore-Dressing 90x60x60mm	<b>D10620</b>

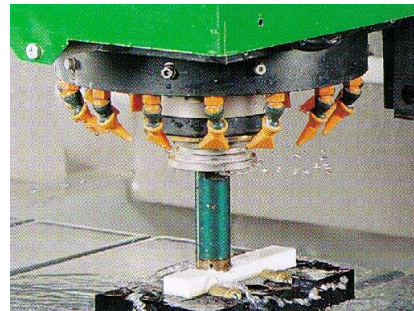
**Dispositivo per ravvivare mole lucidanti**
**Dressing device for polishing wheels.**



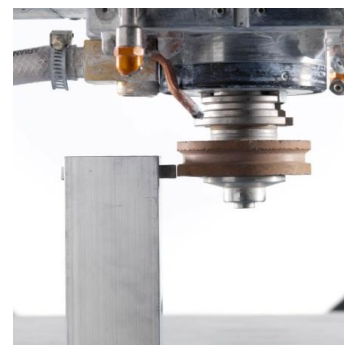

Master 30 only	<b>P6390P0315</b>
Tutte le mc/all mc	<b>P6314P0128</b>
<b>Ricambi - Spare Parts</b>	
Ravvivatore singolo Dressing only	<b>P1214P0180</b>

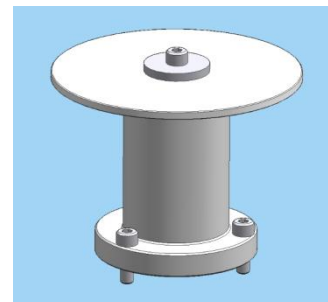
**Dispositivo per ravvivare mole Diamantate**
**Dressing device for Diamond wheels.**

MASTER 3 ax+ 5 ax	<b>P6390P0485</b>
<b>Ricambi - Spare Parts</b>	
Disco-wheel 152x5x32	<b>FNX0150137</b>
Disco-wheel 152x6x32	<b>FNX0150138</b>
Disco-wheel 152x4x32	<b>FNX0150157</b>





## CAD/ CAM SOFTWARE

<p><b>ICAD 2D</b></p> <table border="1"> <tr> <td>ICAD 2D</td> <td><b>P6390P0197</b></td> </tr> <tr> <td>ICAD 2D – 2° Licenza 2° Dongle</td> <td><b>P6390P0475</b></td> </tr> </table>	ICAD 2D	<b>P6390P0197</b>	ICAD 2D – 2° Licenza 2° Dongle	<b>P6390P0475</b>	
ICAD 2D	<b>P6390P0197</b>				
ICAD 2D – 2° Licenza 2° Dongle	<b>P6390P0475</b>				
<p><b>ICAM 2D</b></p> <table border="1"> <tr> <td>ICAM 2D</td> <td><b>P6390P0194</b></td> </tr> <tr> <td>ICAM 2D – 2° Licenza 2° Dongle</td> <td><b>P6390P0472</b></td> </tr> </table>	ICAM 2D	<b>P6390P0194</b>	ICAM 2D – 2° Licenza 2° Dongle	<b>P6390P0472</b>	
ICAM 2D	<b>P6390P0194</b>				
ICAM 2D – 2° Licenza 2° Dongle	<b>P6390P0472</b>				
<p><b>ICAM 3D</b></p> <table border="1"> <tr> <td>ICAM 3D</td> <td><b>P6390P0195</b></td> </tr> <tr> <td>ICAM 3D – 2° Licenza 2° Dongle</td> <td><b>P6390P0473</b></td> </tr> </table>	ICAM 3D	<b>P6390P0195</b>	ICAM 3D – 2° Licenza 2° Dongle	<b>P6390P0473</b>	
ICAM 3D	<b>P6390P0195</b>				
ICAM 3D – 2° Licenza 2° Dongle	<b>P6390P0473</b>				
<p><b>ICAM ART</b></p> <table border="1"> <tr> <td>ICAM ART</td> <td><b>P6390P0196</b></td> </tr> <tr> <td>ICAM ART – 2° Licenza 2° Dongle</td> <td><b>P6390P0474</b></td> </tr> </table>	ICAM ART	<b>P6390P0196</b>	ICAM ART – 2° Licenza 2° Dongle	<b>P6390P0474</b>	
ICAM ART	<b>P6390P0196</b>				
ICAM ART – 2° Licenza 2° Dongle	<b>P6390P0474</b>				

**Intermac**

Via dell'Economia, 40  
 61122 Pesaro PU - Italy  
 Tel. +39 0721 483500  
 Fax +39 0721 481962  
 www.intermac.com  
 intermac.parts@intermac.com

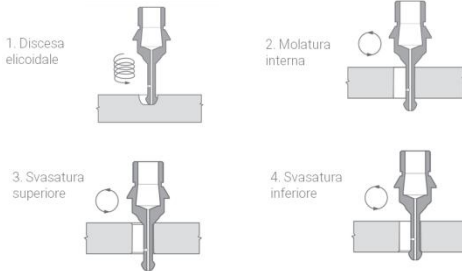

<p><b>UPGRADE X ICAM &amp; OPTION</b>  <b>Controllare se compatibile</b>  <b>Please check if compatible.</b></p> <table border="1"> <tr> <td>ICAM2D → ICAM3D</td> <td><b>2152A0503</b></td> </tr> <tr> <td>ICAM2D → ICAM ART</td> <td><b>2152A0504</b></td> </tr> <tr> <td>ICAM3D → ICAM ART</td> <td><b>2152A0505</b></td> </tr> <tr> <td>POSTPROC. OSAI</td> <td><b>2152A0500</b></td> </tr> <tr> <td>CAMDXF</td> <td><b>2152A0501</b></td> </tr> </table>	ICAM2D → ICAM3D	<b>2152A0503</b>	ICAM2D → ICAM ART	<b>2152A0504</b>	ICAM3D → ICAM ART	<b>2152A0505</b>	POSTPROC. OSAI	<b>2152A0500</b>	CAMDXF	<b>2152A0501</b>	
ICAM2D → ICAM3D	<b>2152A0503</b>										
ICAM2D → ICAM ART	<b>2152A0504</b>										
ICAM3D → ICAM ART	<b>2152A0505</b>										
POSTPROC. OSAI	<b>2152A0500</b>										
CAMDXF	<b>2152A0501</b>										
<p><b>Helix System (no tool)</b>  <b>Controllare se compatibile</b>  <b>Please check if compatible.</b></p> <table border="1"> <tr> <td>Software upgrade</td> <td><b>KR35200199</b></td> </tr> </table>	Software upgrade	<b>KR35200199</b>									
Software upgrade	<b>KR35200199</b>										
<p><b>Bsolid centri lavoro</b>  <b>Bsolid CNC</b></p> <table border="1"> <tr> <td>Bsolid</td> <td><b>P6390P0603</b></td> </tr> <tr> <td>2° Licenza</td> <td><b>P6390P0604</b></td> </tr> <tr> <td>2° Dongle</td> <td></td> </tr> </table>	Bsolid	<b>P6390P0603</b>	2° Licenza	<b>P6390P0604</b>	2° Dongle						
Bsolid	<b>P6390P0603</b>										
2° Licenza	<b>P6390P0604</b>										
2° Dongle											
<p><b>STONECAM 3D – Version 3.3</b>  <b>(USB Dongle for old cnc)</b></p> <table border="1"> <tr> <td>Cad/Cam</td> <td><b>P2152P0053</b></td> </tr> <tr> <td>Laserscan</td> <td><b>P2152P0052</b></td> </tr> </table>	Cad/Cam	<b>P2152P0053</b>	Laserscan	<b>P2152P0052</b>							
Cad/Cam	<b>P2152P0053</b>										
Laserscan	<b>P2152P0052</b>										

**Intermac**

Via dell'Economia, 40  
 61122 Pesaro PU - Italy  
 Tel. +39 0721 483500  
 Fax +39 0721 481962  
 www.intermac.com  
 intermac.parts@intermac.com



Vi preghiamo di contattarci per qualsiasi informazione o ordine al seguente indirizzo:

[Intermac.parts@intermac.com](mailto:Intermac.parts@intermac.com)

indicando nell' **oggetto** il vs numero d'ordine e poi una delle seguenti parole chiave indipendentemente dal tipo macchina:

**INFO** per richieste generali (un codice , un kit, ecc...)  
**OFFER** per richieste di prezzo e disponibilità  
**DOWN** per ordini relativi a MACCHINA FERMA  
**URGENT** per ricambi urgenti  
**STOCK** per ricambi normali non urgenti e per lo stock

Contact us to the following mail address for every information or order:

[Intermac.parts@intermac.com](mailto:Intermac.parts@intermac.com)

indicating in the **subject** your order number and afterwards one of the following keywords regardless of machine type :

**INFO** for general info inquiries (a part number, a kit etc...)  
**OFFER** for a price inquiry  
**DOWN** for a m/c down order  
**URGENT** for an urgent spare parts order  
**STOCK** for a normal or stock spare parts order

**Intermac**

Via dell'Economia, 40  
61122 Pesaro PU - Italy  
Tel. +39 0721 483500  
Fax +39 0721 481962  
www.intermac.com  
intermac.parts@intermac.com





